

# MBD301G, MMBD301LT1G, MMBD301LT3G, SMMBD301LT3G



ON Semiconductor®

[www.onsemi.com](http://www.onsemi.com)

## Silicon Hot-Carrier Diodes

### Schottky Barrier Diodes

These devices are designed primarily for high-efficiency UHF and VHF detector applications. They are readily adaptable to many other fast switching RF and digital applications. They are supplied in an inexpensive plastic package for low-cost, high-volume consumer and industrial/commercial requirements. They are also available in a Surface Mount package.

#### Features

- Extremely Low Minority Carrier Lifetime – 15 ps (Typ)
- Very Low Capacitance – 1.5 pF (Max) @  $V_R = 15\text{ V}$
- Low Reverse Leakage –  $I_R = 13\text{ nAdc}$  (Typ) MBD301, MMBD301
- S Prefix for Automotive and Other Applications Requiring Unique Site and Control Change Requirements; AEC-Q101 Qualified and PPAP Capable
- These Devices are Pb-Free, Halogen Free/BFR Free and are RoHS Compliant

#### MAXIMUM RATINGS

Rating	Symbol	Value	Unit
Reverse Voltage	$V_R$	30	V
Forward Current (DC)	$I_F$	200 (Max)	mA
Total Device Dissipation @ $T_A = 25^\circ\text{C}$ MBD301G MMBD301LT1G, MMBD301LT3G, SMMBD301LT3G	$P_F$	280 200	MW
Derate above $25^\circ\text{C}$ MBD301G MMBD301LT1G, MMBD301LT3G, SMMBD301LT3G		2.8 2.0	mW/ $^\circ\text{C}$
Operating Junction Temperature Range	$T_J$	-55 to +125	$^\circ\text{C}$
Storage Temperature Range	$T_{stg}$	-55 to +150	$^\circ\text{C}$

Stresses exceeding those listed in the Maximum Ratings table may damage the device. If any of these limits are exceeded, device functionality should not be assumed, damage may occur and reliability may be affected.

### 30 VOLTS SILICON HOT-CARRIER DETECTOR AND SWITCHING DIODES



TO-92 2-Lead  
CASE 182  
STYLE 1

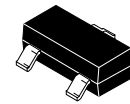

SOT-23 (TO-236)  
CASE 318  
STYLE 8

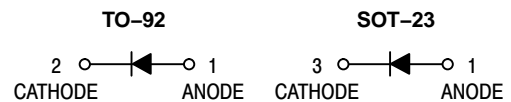

#### MARKING DIAGRAMS

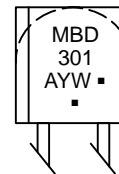

TO-92

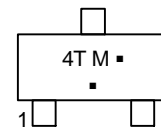

SOT-23

- A = Assembly Location
- Y = Year
- W = Work Week
- 4T = Device Code (SOT-23)
- M = Date Code\*
- = Pb-Free Package

(Note: Microdot may be in either location)

\*Date Code orientation and/or overbar may vary depending upon manufacturing location.

#### ORDERING INFORMATION

See detailed ordering and shipping information in the package dimensions section on page 2 of this data sheet.

## MBD301G, MMBD301LT1G, MMBD301LT3G, SMMBD301LT3G

### ELECTRICAL CHARACTERISTICS (T<sub>A</sub> = 25°C unless otherwise noted)

Characteristic	Symbol	Min	Typ	Max	Unit
Reverse Breakdown Voltage (I <sub>R</sub> = 10 μA)	V <sub>(BR)R</sub>	30	–	–	V
Total Capacitance (V <sub>R</sub> = 15 V, f = 1.0 MHz) Figure 1	C <sub>T</sub>	–	0.9	1.5	pF
Reverse Leakage (V <sub>R</sub> = 25 V) Figure 3	I <sub>R</sub>	–	13	200	nAdc
Forward Voltage (I <sub>F</sub> = 1.0 mAdc) Figure 4	V <sub>F</sub>	–	0.38	0.45	Vdc
Forward Voltage (I <sub>F</sub> = 10 mAdc) Figure 4	V <sub>F</sub>	–	0.52	0.6	Vdc

Product parametric performance is indicated in the Electrical Characteristics for the listed test conditions, unless otherwise noted. Product performance may not be indicated by the Electrical Characteristics if operated under different conditions.

### ORDERING INFORMATION

Device	Package	Shipping†
MBD301G	TO-92 (Pb-Free)	5,000 Units / Bulk
MMBD301LT1G	SOT-23 (Pb-Free)	3,000 / Tape & Reel
MMBD301LT3G	SOT-23 (Pb-Free)	10,000 / Tape & Reel
SMMBD301LT3G	SOT-23 (Pb-Free)	10,000 / Tape & Reel

†For information on tape and reel specifications, including part orientation and tape sizes, please refer to our Tape and Reel Packaging Specifications Brochure, BRD8011/D.

TYPICAL ELECTRICAL CHARACTERISTICS

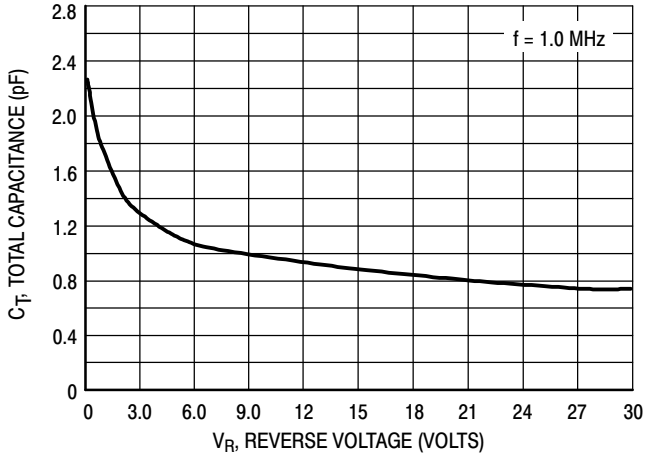

Figure 1. Total Capacitance

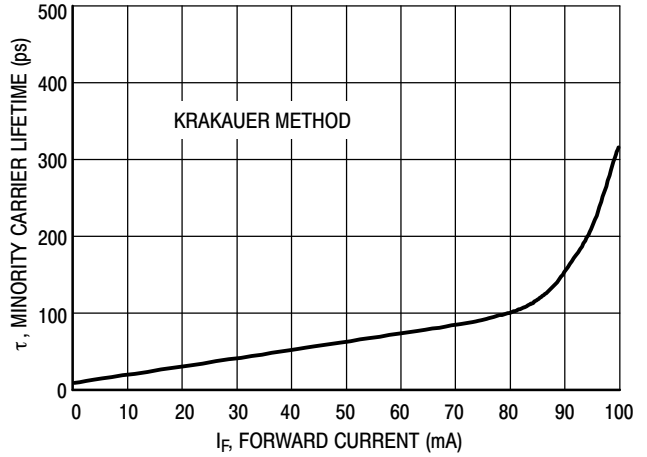

Figure 2. Minority Carrier Lifetime

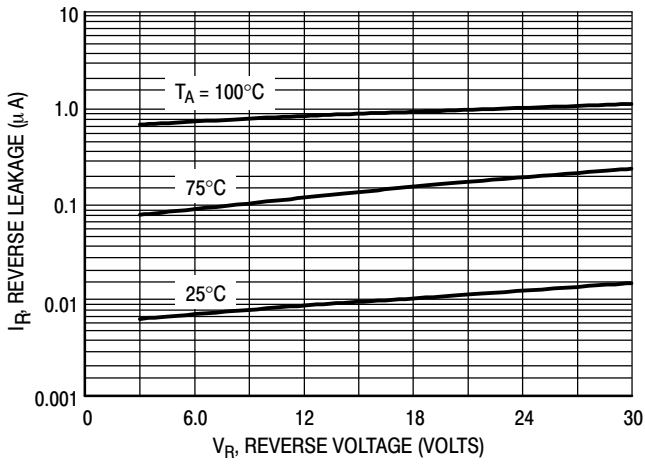

Figure 3. Reverse Leakage

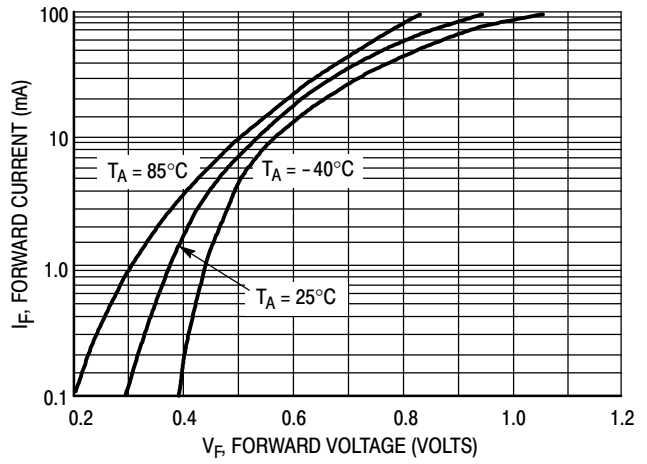

Figure 4. Forward Voltage

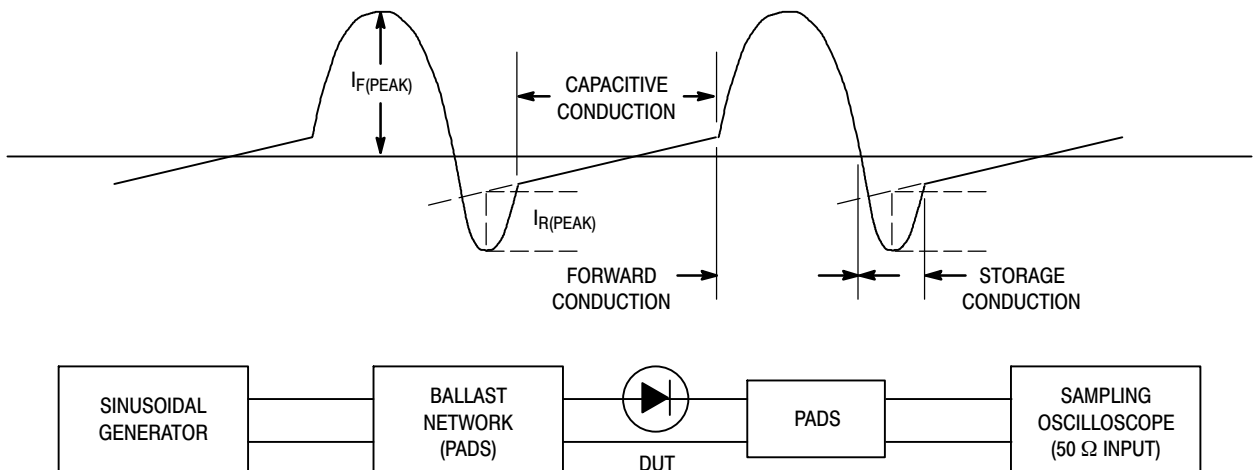
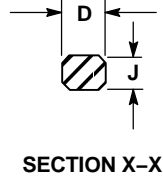
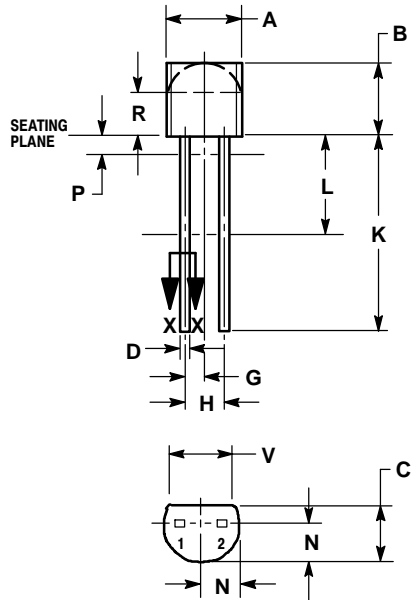

Figure 5. Krakauer Method of Measuring Lifetime

# MBD301G, MMBD301LT1G, MMBD301LT3G, SMMBD301LT3G

## PACKAGE DIMENSIONS

TO-92 (TO-226AC)  
CASE 182-06  
ISSUE L



NOTES:

1. DIMENSIONING AND TOLERANCING PER ANSI Y14.5M, 1982.
2. CONTROLLING DIMENSION: INCH.
3. CONTOUR OF PACKAGE BEYOND ZONE R IS UNCONTROLLED.
4. LEAD DIMENSION IS UNCONTROLLED IN P AND BEYOND DIMENSION K MINIMUM.

DIM	INCHES		MILLIMETERS	
	MIN	MAX	MIN	MAX
A	0.175	0.205	4.45	5.21
B	0.170	0.210	4.32	5.33
C	0.125	0.165	3.18	4.19
D	0.016	0.021	0.407	0.533
G	0.050 BSC		1.27 BSC	
H	0.100 BSC		2.54 BSC	
J	0.014	0.016	0.36	0.41
K	0.500	---	12.70	---
L	0.250	---	6.35	---
N	0.080	0.105	2.03	2.66
P	---	0.050	---	1.27
R	0.115	---	2.93	---
V	0.135	---	3.43	---

STYLE 1:

- PIN 1. ANODE
- CATHODE

# MBD301G, MMBD301LT1G, MMBD301LT3G, SMMBD301LT3G

## PACKAGE DIMENSIONS

### SOT-23 (TO-236) CASE 318-08 ISSUE AR

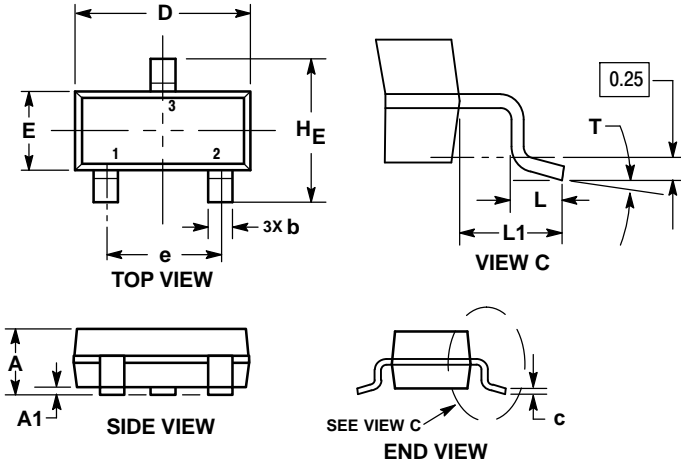

#### NOTES:

1. DIMENSIONING AND TOLERANCING PER ASME Y14.5M, 1994.
2. CONTROLLING DIMENSION: MILLIMETERS.
3. MAXIMUM LEAD THICKNESS INCLUDES LEAD FINISH. MINIMUM LEAD THICKNESS IS THE MINIMUM THICKNESS OF THE BASE MATERIAL.
4. DIMENSIONS D AND E DO NOT INCLUDE MOLD FLASH, PROTRUSIONS, OR GATE BURRS.

DIM	MILLIMETERS			INCHES		
	MIN	NOM	MAX	MIN	NOM	MAX
A	0.89	1.00	1.11	0.035	0.039	0.044
A1	0.01	0.06	0.10	0.000	0.002	0.004
b	0.37	0.44	0.50	0.015	0.017	0.020
c	0.08	0.14	0.20	0.003	0.006	0.008
D	2.80	2.90	3.04	0.110	0.114	0.120
E	1.20	1.30	1.40	0.047	0.051	0.055
e	1.78	1.90	2.04	0.070	0.075	0.080
L	0.30	0.43	0.55	0.012	0.017	0.022
L1	0.35	0.54	0.69	0.014	0.021	0.027
HE	2.10	2.40	2.64	0.083	0.094	0.104
T	0°	---	10°	0°	---	10°

#### STYLE 8:

1. ANODE
2. NO CONNECTION
3. CATHODE

### RECOMMENDED SOLDERING FOOTPRINT\*

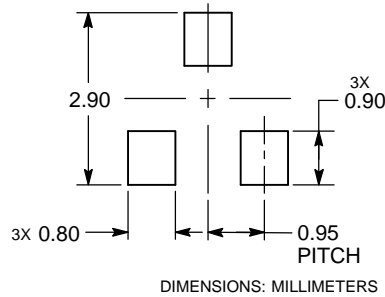

\*For additional information on our Pb-Free strategy and soldering details, please download the ON Semiconductor Soldering and Mounting Techniques Reference Manual, SOLDERRM/D.

ON Semiconductor and are trademarks of Semiconductor Components Industries, LLC dba ON Semiconductor or its subsidiaries in the United States and/or other countries. ON Semiconductor owns the rights to a number of patents, trademarks, copyrights, trade secrets, and other intellectual property. A listing of ON Semiconductor's product/patent coverage may be accessed at [www.onsemi.com/site/pdf/Patent-Marking.pdf](http://www.onsemi.com/site/pdf/Patent-Marking.pdf). ON Semiconductor reserves the right to make changes without further notice to any products herein. ON Semiconductor makes no warranty, representation or guarantee regarding the suitability of its products for any particular purpose, nor does ON Semiconductor assume any liability arising out of the application or use of any product or circuit, and specifically disclaims any and all liability, including without limitation special, consequential or incidental damages. Buyer is responsible for its products and applications using ON Semiconductor products, including compliance with all laws, regulations and safety requirements or standards, regardless of any support or applications information provided by ON Semiconductor. "Typical" parameters which may be provided in ON Semiconductor data sheets and/or specifications can and do vary in different applications and actual performance may vary over time. All operating parameters, including "Typicals" must be validated for each customer application by customer's technical experts. ON Semiconductor does not convey any license under its patent rights nor the rights of others. ON Semiconductor products are not designed, intended, or authorized for use as a critical component in life support systems or any FDA Class 3 medical devices or medical devices with a same or similar classification in a foreign jurisdiction or any devices intended for implantation in the human body. Should Buyer purchase or use ON Semiconductor products for any such unintended or unauthorized application, Buyer shall indemnify and hold ON Semiconductor and its officers, employees, subsidiaries, affiliates, and distributors harmless against all claims, costs, damages, and expenses, and reasonable attorney fees arising out of, directly or indirectly, any claim of personal injury or death associated with such unintended or unauthorized use, even if such claim alleges that ON Semiconductor was negligent regarding the design or manufacture of the part. ON Semiconductor is an Equal Opportunity/Affirmative Action Employer. This literature is subject to all applicable copyright laws and is not for resale in any manner.

### PUBLICATION ORDERING INFORMATION

#### LITERATURE FULFILLMENT:

Literature Distribution Center for ON Semiconductor  
 19521 E. 32nd Pkwy, Aurora, Colorado 80011 USA  
**Phone:** 303-675-2175 or 800-344-3860 Toll Free USA/Canada  
**Fax:** 303-675-2176 or 800-344-3867 Toll Free USA/Canada  
**Email:** [orderlit@onsemi.com](mailto:orderlit@onsemi.com)

**N. American Technical Support:** 800-282-9855 Toll Free  
 USA/Canada  
**Europe, Middle East and Africa Technical Support:**  
 Phone: 421 33 790 2910  
**Japan Customer Focus Center**  
 Phone: 81-3-5817-1050

**ON Semiconductor Website:** [www.onsemi.com](http://www.onsemi.com)

**Order Literature:** <http://www.onsemi.com/orderlit>

For additional information, please contact your local Sales Representative